

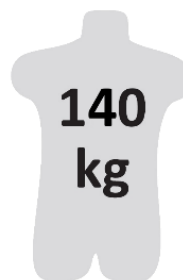

FA 20 402 15

P. 1 | 2

Helixon-S



①



②

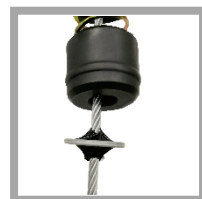

③









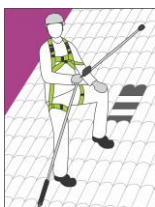
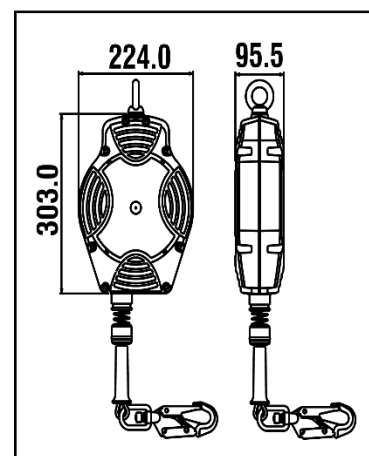

④



⑤

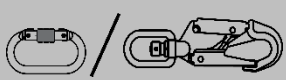

HS CODE
84798997
CARTON SIZE / PCS.
60 x 40 x 24 cm / 2
AET (EU) N°2777/10833-01/E01-03
Satra Technology Europe Ltd., N° 2777, Bracetown Business Park, Clonee, Dublin, D15YN2P, Ireland
MODULE D FI14/14003.02
SGS Fimko Oy, N°0598 Takomotie 8, 00380 HELSINKI, Finland

REF.	FA 20 402 15
LG.  KG	15 m
CE	EN 360:2002
MAT.  	Polyamide 6 - 30% fiber glass  STEEL Ø4.8 mm
	 STEEL FA 50 101 17 / FA 50 203 20 with fall indicator
	x2
R(kN)	12 kN
	YES PPE-R/11.060
	8.01 KG



Longueur Poids maxi utilisateur
Length Max. user weight
Longitud Peso máximo del usuario
Lunghezza Peso Max. dell'utente
Länge Höchstgewicht des Benutzers

MAT.



Matière carter / câble
Material of casing / wire rope
Material cárter / cable
Material dei carter / cavo
Material Gehäuse / Seil



Matière connecteur haut / connecteur bas
Material of top connector / bottom connector
Material conector alto / conector bajo
Materiale connettore alto / connettore basso
Material oberes / unteres Verbindungselement



Nombre d'émerillons
Number of swivels
Cantidad de eslabones giratorios
Numero di tornichetti
Anzahl der Wirbel



Homologué pour le travail à proximité d'arêtes vives
Approved for work near sharp edges
Homologado para trabajo cerca de aristas vivas
Omologato per lavoro in prossimità di spigoli vivi
Zugelassen für Arbeiten in der Nähe scharfer Kanten